



Müllabfuhrtermine 2024

Gemeinde Hitzhofen
 alle Ortsteile

Problemmüllaktion
 Freitag, 01.03.2024, 10.15 - 11.15 Uhr
 am Bauhof in Hitzhofen bei der Feuerwehr,
 Florianweg 1

JANUAR		FEBRUAR		MÄRZ		APRIL		MAI		JUNI	
01 Mo	Neujahr	01 Do	Gelber Sack	01 Fr	Problemmüll	01 Mo	Ostermontag	01 Mi	Tag der Arbeit	01 Sa	Bioabfall
02 Di		02 Fr		02 Sa		02 Di		02 Do		02 So	
03 Mi		03 Sa		03 So		03 Mi	Restmüll	03 Fr		03 Mo	Altpapier
04 Do		04 So		04 Mo		04 Do		04 Sa	Bioabfall	04 Di	
05 Fr	Gelber Sack	05 Mo		05 Di	Restmüll	05 Fr		05 So		05 Mi	
06 Sa	Hl. 3 Könige	06 Di	Restmüll	06 Mi		06 Sa	Bioabfall	06 Mo	Altpapier	06 Do	
07 So		07 Mi		07 Do		07 So		07 Di		07 Fr	
08 Mo		08 Do		08 Fr	Bioabfall	08 Mo	Altpapier	08 Mi		08 Sa	
09 Di		09 Fr	Bioabfall	09 Sa		09 Di		09 Do	Christi Himmelfahrt	09 So	
10 Mi	Restmüll	10 Sa		10 So		10 Mi		10 Fr		10 Mo	
11 Do		11 So		11 Mo	Altpapier	11 Do		11 Sa		11 Di	Restmüll
12 Fr	Bioabfall	12 Mo	Altpapier	12 Di		12 Fr		12 So		12 Mi	
13 Sa		13 Di		13 Mi		13 Sa		13 Mo		13 Do	
14 So		14 Mi		14 Do		14 So		14 Di	Restmüll	14 Fr	Bioabfall
15 Mo	Altpapier	15 Do		15 Fr		15 Mo		15 Mi		15 Sa	
16 Di		16 Fr		16 Sa		16 Di	Restmüll	16 Do		16 So	
17 Mi		17 Sa		17 So		17 Mi		17 Fr	Bioabfall	17 Mo	
18 Do		18 So		18 Mo		18 Do		18 Sa		18 Di	
19 Fr		19 Mo		19 Di	Restmüll	19 Fr	Bioabfall	19 So	Pfingstsonntag	19 Mi	
20 Sa		20 Di	Restmüll	20 Mi		20 Sa		20 Mo	Pfingstmontag	20 Do	Gelber Sack
21 So		21 Mi		21 Do		21 So		21 Di		21 Fr	
22 Mo		22 Do		22 Fr	Bioabfall	22 Mo		22 Mi		22 Sa	
23 Di	Restmüll	23 Fr	Bioabfall	23 Sa		23 Di		23 Do		23 So	
24 Mi		24 Sa		24 So		24 Mi		24 Fr	Gelber Sack	24 Mo	
25 Do		25 So		25 Mo		25 Do	Gelber Sack	25 Sa		25 Di	Restmüll
26 Fr	Bioabfall	26 Mo		26 Di		26 Fr		26 So		26 Mi	
27 Sa		27 Di		27 Mi		27 Sa		27 Mo		27 Do	
28 So		28 Mi		28 Do	Gelber Sack	28 So		28 Di	Restmüll	28 Fr	Bioabfall
29 Mo		29 Do	Gelber Sack	29 Fr	Karfreitag	29 Mo		29 Mi		29 Sa	
30 Di				30 Sa		30 Di	Restmüll	30 Do	Fronleichnam	30 So	
31 Mi				31 So	Ostersonntag	31 Fr		31 Fr			

JULI		AUGUST		SEPTEMBER		OKTOBER		NOVEMBER		DEZEMBER	
01 Mo	Altpapier	01 Do		01 So		01 Di	Restmüll	01 Fr	Allerheiligen	01 So	
02 Di		02 Fr		02 Mo		02 Mi		02 Sa	Bioabfall	02 Mo	
03 Mi		03 Sa		03 Di	Restmüll	03 Do	Tag der Deutschen Einheit	03 So		03 Di	
04 Do		04 So		04 Mi		04 Fr		04 Mo		04 Mi	
05 Fr		05 Mo		05 Do		05 Sa	Bioabfall	05 Di		05 Do	Gelber Sack
06 Sa		06 Di	Restmüll	06 Fr	Bioabfall	06 So		06 Mi		06 Fr	
07 So		07 Mi		07 Sa		07 Mo		07 Do	Gelber Sack	07 Sa	
08 Mo		08 Do		08 So		08 Di		08 Fr		08 So	
09 Di	Restmüll	09 Fr	Bioabfall	09 Mo		09 Mi		09 Sa		09 Mo	
10 Mi		10 Sa		10 Di		10 Do	Gelber Sack	10 So		10 Di	Restmüll
11 Do		11 So		11 Mi		11 Fr		11 Mo		11 Mi	
12 Fr	Bioabfall	12 Mo		12 Do	Gelber Sack	12 Sa		12 Di	Restmüll	12 Do	
13 Sa		13 Di		13 Fr		13 So		13 Mi		13 Fr	Bioabfall
14 So		14 Mi		14 Sa		14 Mo		14 Do		14 So	
15 Mo		15 Do	Maria Himmelfahrt	15 So		15 Di	Restmüll	15 Fr	Bioabfall	15 Sa	
16 Di		16 Fr	Gelber Sack	16 Mo		16 Mi		16 Sa		16 Mo	Altpapier
17 Mi		17 Sa		17 Di	Restmüll	17 Do		17 So		17 Di	
18 Do	Gelber Sack	18 So		18 Mi		18 Fr	Bioabfall	18 Mo	Altpapier	18 Mi	
19 Fr		19 Mo		19 Do		19 Sa		19 Di		19 Do	
20 Sa		20 Di	Restmüll	20 Fr	Bioabfall	20 So		20 Mi		20 Fr	
21 So		21 Mi		21 Sa		21 Mo	Altpapier	21 Do		21 Sa	
22 Mo		22 Do		22 So		22 Di		22 Fr		22 So	
23 Di	Restmüll	23 Fr	Bioabfall	23 Mo	Altpapier	23 Mi		23 Sa		23 Mo	Restmüll
24 Mi		24 Sa		24 Di		24 Do		24 So		24 Di	
25 Do		25 So		25 Mo		25 Fr		25 Mo		25 Mi	1. Weihnachtsfeiertag
26 Fr	Bioabfall	26 Mo	Altpapier	26 Do		26 Sa		26 Di	Restmüll	26 Do	2. Weihnachtsfeiertag
27 Sa		27 Di		27 Fr		27 So		27 Mi		27 Fr	
28 So		28 Mi		28 Sa		28 Mo		28 Do		28 Sa	Bioabfall
29 Mo	Altpapier	29 Do		29 So		29 Di	Restmüll	29 Fr	Bioabfall	29 So	
30 Di		30 Fr		30 Mo		30 Mi		30 Sa		30 Mo	
31 Mi		31 Sa				31 Do				31 Di	



MyMüllApp
 mit automatischer
 Erinnerungsfunktion

RM = Restmüll













AP = Altpapier









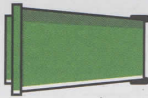

GS = Gelber Sack





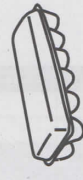



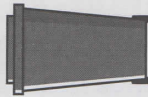

BIO = Bioabfall



PM = Problemmüll



Abfalltrennung

 Biotonne	 Obst, Gemüse	 Speisereste
	 Fleisch, Wurst, Knochen	 Kaffeefilter, Teebeutel
 Brot	 Eierschalen	 Pflanzen
 Zweige, Äste, Laub (Kleinmengen < 10l)	 keine Plastiktüten oder kompostierbare Biomüllbeutel	
 Papiertüten	 Verpackungen aus Papier / Pappe	

 Papiertonne	 Zeitung	 Umschlag, Brief
	 Magazin	 Papiertüte
 Papierrolle	 Katalog	 Eierkarton
 Buch	 Karton	 Zigaretten

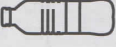
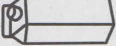
 Restabfalltonne	 Kehricht	 Windel
	 Schwamm	 Zahnbürste
 Staubsaugerbeutel	 Tapete	 Medikamente
 kaputtges Spielzeug	 Keramik, Porzellan (keine Fliesen)	 Zigaretten

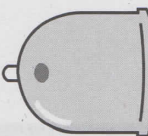
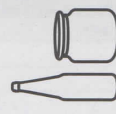
 Gelber Sack	 Kunststoffverpackung	 Verpackungsstyropor
	 Kunststoffflasche	 Getränkkarton

 Sammelstelle Iglu	 Glas	 Dosen
---	---	--